



Vertical Baffle Systems

HERADESIGN® Baffle Element Profile

(HERADESIGN® Baffle Basic)











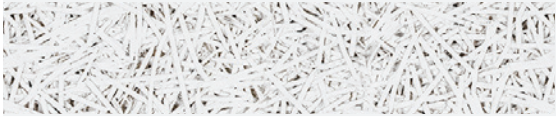
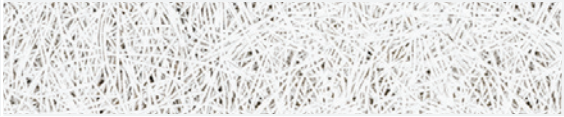









Individual / Grouped



- HERADESIGN® Baffle Element Profile is a range of high performance, wood wool acoustical baffles, available in a variety of surfaces and dimensions
- Baffles are available with a HERADESIGN® Fine and Superfine surface
- Two-layer baffle with HERADESIGN® cover layers and anodised aluminium profile on the top side
- Available with a 2500mm maximum length and 200mm minimum height
- Available in Vario Design and RAL and NCS colours
- Various pre-assembled HERADESIGN® hangers can be selected for extra flexibility
- Special shapes and dimensions available on request



Vertical Baffle System
HERADESIGN® Baffle Element Profile
 Individual / Grouped

Surface		HERADESIGN® Fine, Fine A2		HERADESIGN® Superfine, Superfine A2							
											
Thickness (mm)		30									
Dimensions (mm)		600 x 300 1200 x 300 1800 x 300	600 x 600 1200 x 600 1800 x 600	Additional dimensions available on request. Maximum length = 2500mm							
System		Hanging wire kit (with/without ceiling rail) Short hanger kit with ceiling rail option U-Profile grouping option									
Weight		HERADESIGN® Fine 600 x 300: 3.1 kg/pc 1200 x 300: 6.3 kg/pc 1800 x 300: 9.4 kg/pc 600 x 600: 6.1 kg/pc 1200 x 600: 12.2 kg/pc 1800 x 600: 18.3 kg/pc	HERADESIGN® Fine A2 600 x 300: 4.8 kg/pc 1200 x 300: 9.7 kg/pc 1800 x 300: 14.5 kg/pc 600 x 600: 9.5 kg/pc 1200 x 600: 19.0 kg/pc 1800 x 600: 28.5 kg/pc	HERADESIGN® Superfine 600 x 300: 3.0 kg/pc 1200 x 300: 6.0 kg/pc 1800 x 300: 9.0 kg/pc 600 x 600: 5.8 kg/pc 1200 x 600: 11.6 kg/pc 1800 x 600: 17.4 kg/pc	HERADESIGN® Superfine A2 600 x 300: 4.5 kg/pc 1200 x 300: 8.9 kg/pc 1800 x 300: 13.4 kg/pc 600 x 600: 8.8 kg/pc 1200 x 600: 17.6 kg/pc 1800 x 600: 26.4 kg/pc						
Colours		Standard colours		vd Vario Design colours							
		 White Similar to RAL 9010	 Beige Natural tone 13	 Granite	 Steel	 Green Marble	 Copper	 Oak	 Brass	 Sandstone	 Concrete
		<ul style="list-style-type: none"> • Other colours from popular RAL and NCS colour systems are available. • Deviations in colour and visual appearance may occur due to the rough fibre and panel surface. 									
Sound absorption		HERADESIGN® Baffle Element Profile Fine α_w = up to 0.55 NRC = up to 0.60				HERADESIGN® Baffle Element Profile Superfine α_w = up to 0.55 NRC = up to 0.60					
Fire reaction		Euroclass B-s1,d0 and A2-s1,d0 according EN 13501-1									
Humidity resistance		Not suitable for indoor swimming pools, underground garages and outdoor areas									
Cleanability											
Sustainability											

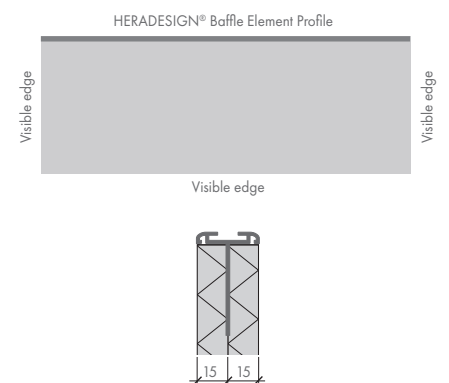
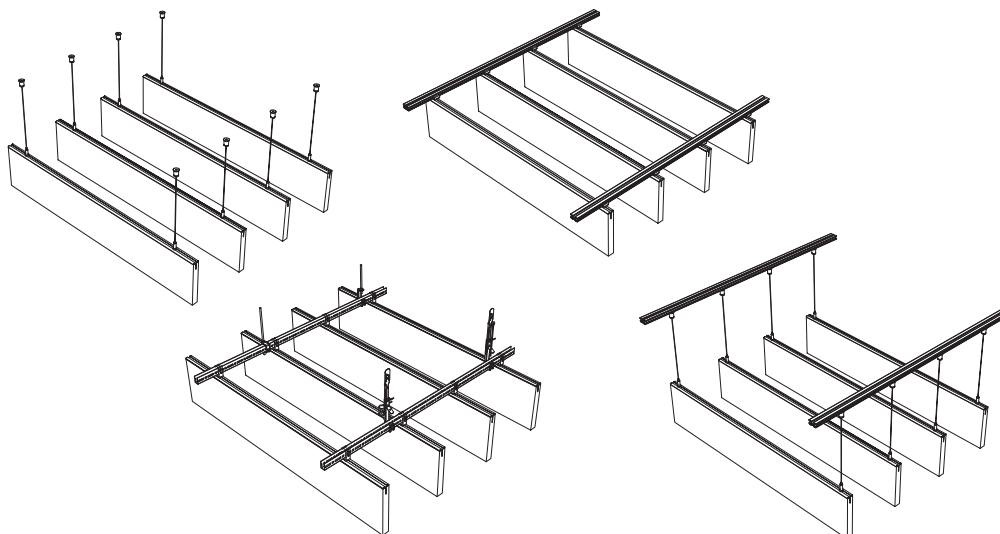

Two-layer baffle with HERADESIGN® cover layers and anodised aluminium profile on the top side.

[Previous page] HERADESIGN® Baffle Element Profile (ASTARTA Organic Business Center, Ukraine)

Options with this icon are available from our **Vario Design** range. Some combinations of colours and/or perforations are not available for every product. Products may vary from country to country. Please contact your local sales representative. For further information and legal notice, please visit our website. knaufceilingsolutions.com